

UT2F/E4-0AUL

cylindrical ultrasonic



Micro Detectors

Italian Sensors Technology



Indicative image

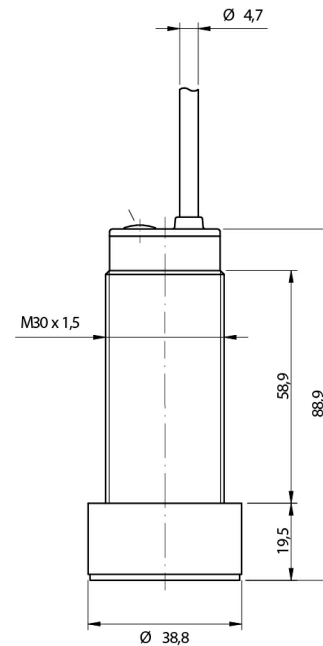

Detection properties

Nominal sensing distance	6000mm
Thermal drift of Sr	± 5%(analog) - ± 8%(digital)
Repeat Accuracy	0,5%
Beam angle	± 9°
Resolution	6mm
Sensitivity adjustment	Teach-in button
Hysteresis	1%
thermal compensation	Yes
Minimum sensing distance (blind zone)	350mm
Linearity error	1%

Application

Function Principle

Diffuse reflection

Outputs

Output type

NPN + 4...20mA

Output Function

NO/NC + positive/negative slope

Switching frequency

1Hz

Response time	600ms
---------------	-------

Electrical data

Operating Voltage	12 - 30Vdc
No-Load supply current	≤50mA
Load current	100mA
Leakage current	10µA @ 30Vcc
Output voltage drop	2,2Vmax. @ IL=100 mA
Max ripple content	5%
LED indicators	Green LED: echo active - Yellow LED: output active
Time delay before availability	≤ 500ms(digital)-≤ 900ms(analog)
Short-circuit protection	Yes
Reverse Polarity Protection	Yes
Impulsive Overvoltage Protection	Yes

Mechanical data

Dimensions	∅ 38,8mm / L = 89mm
Weight	300g
Housing Material	PBT
Connections	2m PVC Cable
Active Head Material	Epoxy-glass resin
Tightening torque	1,5Nm
Operating temperature	- 20°C...+ 70°C
Storage temperature	- 35°C...+ 70° C (without freeze)
Transducer Frequency	75KHz
Diameter/Dimension	M30

Test/Approvals

Approvals	CE cULus
EMC compatibility	IEC 60947-5-2
Shocks and vibrations	IEC EN 60947-5-2 / 7.4
Degree of protection	IP67

Accessories

Supplied Accessories	2 x M30x1,5 nuts, 2 flexible washers ∅ 30
----------------------	---

ELECTRICAL DIAGRAMS OF THE CONNECTIONS

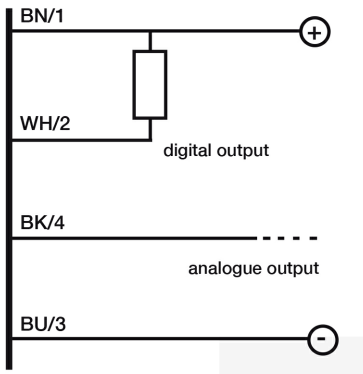

CONNECTOR

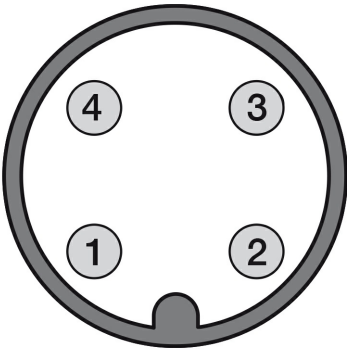

RESPONSE CURVES

Disassamento Parallelo

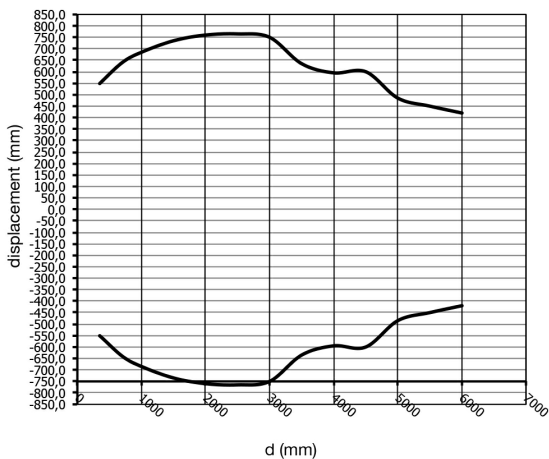

M.D.Micro Detectors S.p.A.

Strada S.Caterina, 235

41122 Modena (MO)

Tel. 059 420411

Fax 059 253973

E-mail info@microdetectors.com

date of printing

05/02/2021 08:27:09